

# Navodila za uporabo

## Operating Instructions

14742f

**CE** **NH-NV stikalne letve, velikost 00 za 185 mm busbar sistem;**  
**1-polna in 3-polna**



**NH strip-type fuse-switch-disconnector size 00 for 185mm**  
**busbar systems 1- and 3-pole switchable**

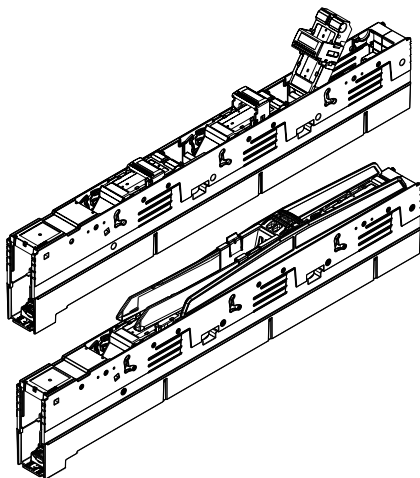

**(SLO) Nasvet**

Z NV/NH varovalnimi stikali je dovoljeno rokovati le elektrotehnično pooblaščenim osebam po standardu IEC/EN 50110-1.

**(EN) Advice**

*Working with NH fuse handles is only allowed for electrically instructed or skilled persons according to IEC/EN 50110-1.*



**(SLO) Nasvet**

NV/NH varovalke pod bremenom se lahko vstavijo ali izvlečejo le ob uporabi ročaja z rokavico in zaščitnim vizirjem za zaščito obraza (po DIN VDE 0105-100, odstavek 7.4.1).

**(EN) Advice**

*Current-carrying fuse-links are only allowed to be inserted or extracted by using a NH fuse-handle with sleeve and wearing an additional face shield (s. also DIN VDE 0105-100, clause 7.4.1).*

**1) Odstranitev zgornjega dela stikalne letve**  
*Removing of upper section of disconnecter*



Odstrani zgornji del le, če nimate talilnih vložkov v stikalni letvi!  
*Remove upper section only without fuse-links!*





**2) Odklop**  
*Switch-off*



Zaprtje/Odprtje  
 Hitro!  
*On/Off:  
 Move lever quickly!*

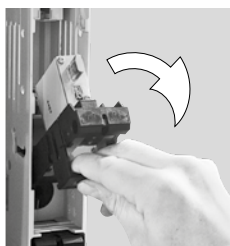

**3) 1-polna verzija**  
*1-pole version*



**3) 1-polna verzija**  
*1-pole version*

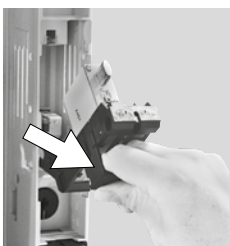

**4) 3-polna verzija**  
*3-pole version*



**5) Vstavev talilnega vložka**  
*Insert of fuse-links*



**6) Odstranitev talilnega vložka**  
*Remove of fuse-link*

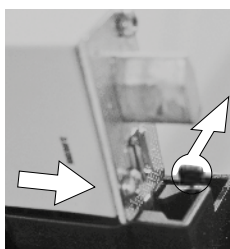

**7) Pozicija odstranitve talilnega vložka 3-polna verzija**  
*Fuse-remove position 3-pole version*

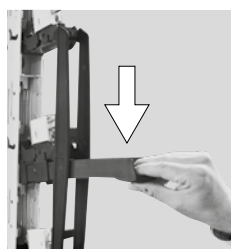
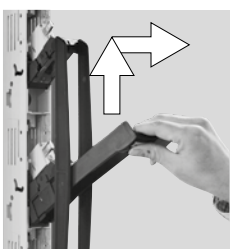

**8) Park pozicija 3-polna stikalna**  
*Park position 3-pole switchable*

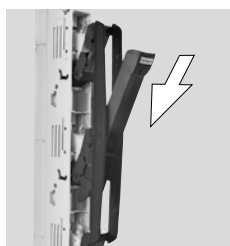
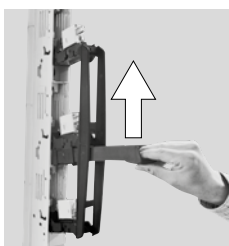

**9) Zaklep ločilnika**  
*Locking*



### 10) Zložljiv ročaj, obrnitev 1-pola Retractable handle 1-pole switching



### 11) Zbiralni sistem Busbar terminal



Debelina zbiralk 5-10 mm, 6 Nm  
Busbar thickness 5-10mm 6Nm

### 12) Priklon zgoraj Connection top

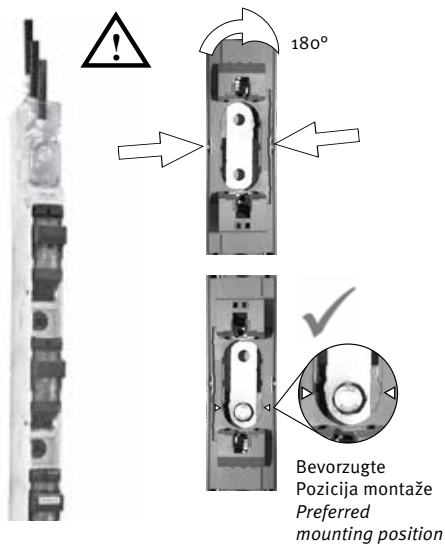

#### \* Priklon aluminijevih vodnikov:

Mehansko odstrani izolacijo na koncu vodnika tik pred priključitvijo, ter namaži z mazivom za boljšo prevodnost.

#### \* Connection of aluminum conductors:

Remove mechanically the oxide coating at the conductor ends immediately before connection and treat with acid-and alkali-free grease.

### 13) Priklon spodaj Connection bottom

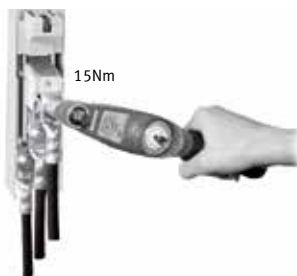
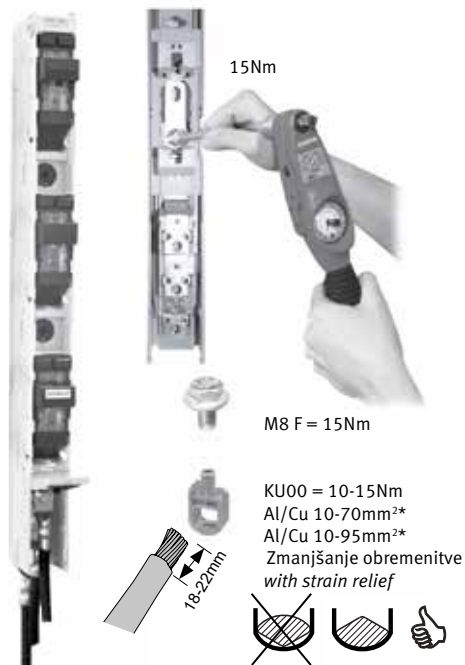

**14)** Pozicija mikro stikala  
*switch position indicator*



**15)** Park pozicija 1-pol  
*Park position 1-pole*



**16)** Montaža z busbar-zbiralčnim adapterjem  
*Mounting on busbar adapter*

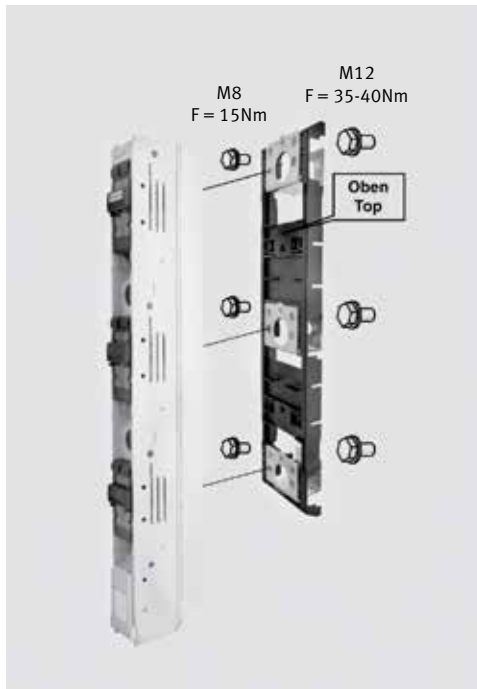

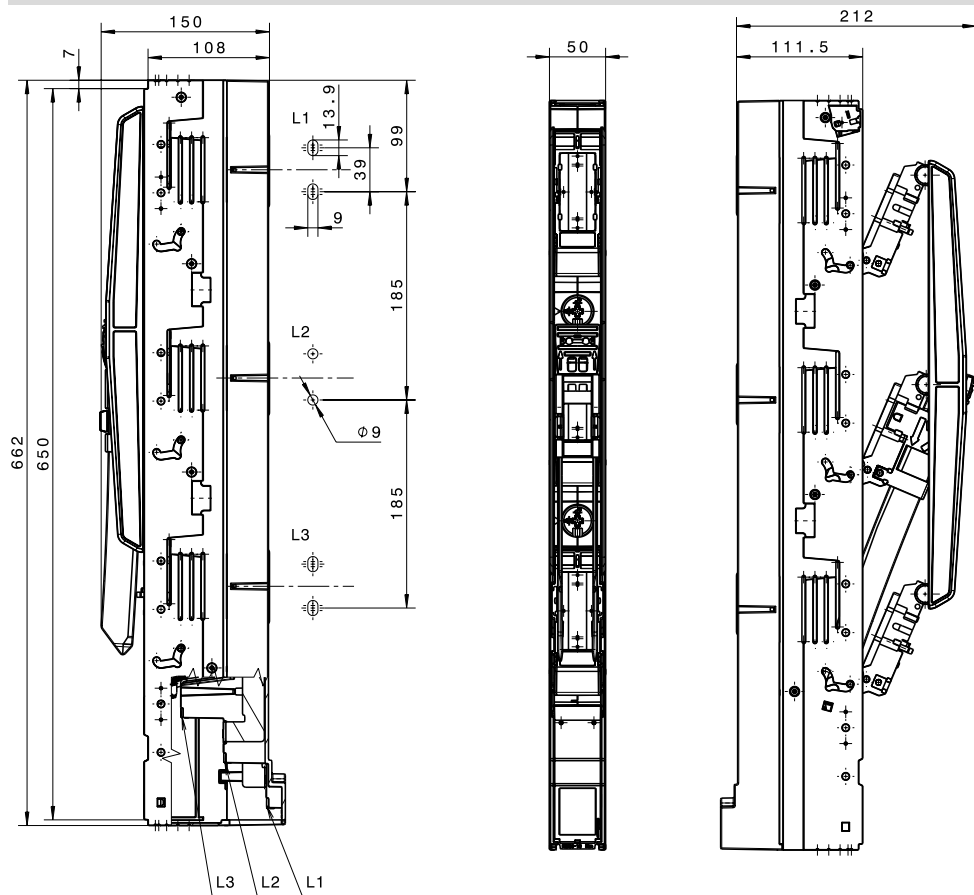
**17) Dimenzije**  
*Dimensions*

NL

**Montage instructie**

**Mespatroonlastscheiderstrook NH-00**  
**voor 185mm railsysteem**  
**één- en driepolig schakelbaar**

	<b>Waarschuwing!</b>
	Gevaarlijke elektrische spanning! Dit kan leiden tot elektrische schokken en verbrandingen. Voor het begin van de werkzaamheden de installatie spanningsloos schakelen.



**Alleen mespatronen gebruiken met verzilverde messen resp. verzilverde scheidingsmessen!**

- 1) Demontage bovendeel mespatroonlastscheiderstrook  
Bovendeel enkel te verwijderen zonder geplaatste mespatronen (scheidingsmessen)
- 2) Uitschakelen  
In- en uitschakelen: snel schakelen
- 3) Individueel eenpolig schakelbare uitvoering
- 4) Driepolig schakelbare uitvoering
- 5) Plaatsen mespatroon in schakelkap
- 6) Verwijderen mespatroon uit schakelkap
- 7) Verwijderen mespatroon uit schakelkap driepolig schakelbare uitvoering
- 8) Parkeermogelijkheid driepolig schakelbare uitvoering
- 9) Hangslotvergendeling
- 10) Handgreep schakelkap eenpolig schakelbare uitvoering uitklapbaar
- 11) Ophaakklem type SK  
Dikte railsysteem 5-10mm  
6Nm
- 12) Aansluiting bovenaan
- 13) Aansluiting onderaan  
F = 15Nm  
KU00 = 10Nm  
Al/Cu 10-70mm<sup>2</sup>  
Al/Cu 10-95mm<sup>2</sup>  
met trekontlasting  
P00 = 2,6Nm  
Al/Cu 10-70mm<sup>2</sup>  
S00 = 2,6Nm  
Cu 1,5-70mm<sup>2</sup>
- 14) Schakelstand aanduiding
- 15) Parkeermogelijkheid eenpolig schakelbare uitvoering
- 16) Montage op stroomrail adapter Bovenkant
- 17) Afmetingen
- 18) Afmetingen

F

**Notice d'installation**

**Réglette porte-fusible sectionnable Taille 00**  
**à entraxe 185mm,**  
**à 1- ou 3 pôles commutés**

	<b>Avertissement!</b>
	Tension électrique dangereuse! Ceci peut mener aux chocs et aux combustions électriques. Avant d'effectuer des travaux veuillez à mettre l'installation hors tension.



**Utiliser uniquement des fusibles à couteaux ou barrettes de neutre argentés!**

- 1) Démontage du capot sectionnable Enlèvement du capot sectionnable seulement sans fusibles montés
- 2) Déclencher  
Enclencher et déclencher: tirer d'un coup sec
- 3) Individuellement sectionnable unipolaire
- 4) Trois pôles commutés
- 5) Mise en place du fusible dans la coiffe porte-fusible
- 6) Enlèvement du fusible de la coiffe porte-fusible
- 7) Enlèvement du fusible de la coiffe porte-fusible à trois pôles commutés
- 8) Position de mise en attente de la coiffe porte-fusible à trois pôles commutés (Parqué)
- 9) Dispositif à cadenas
- 10) Poignée escamotable coiffe porte-fusible sectionnable unipolaire
- 11) Etrier de serrage SK  
Epaisseur barres de cuivre 5-10mm  
6Nm
- 12) Raccordement par le haut
- 13) Raccordement par le bas  
F = 15Nm  
KU00 = 10Nm  
Al/Cu 10-70mm<sup>2</sup>  
Al/Cu 10-95mm<sup>2</sup>  
avec décharge de traction  
P00 = 2,6Nm  
Al/Cu 10-70mm<sup>2</sup>  
S00 = 2,6Nm  
Cu 1,5-70mm<sup>2</sup>
- 14) Contact auxiliaire de précoupure et de position
- 15) Position de mise en attente de la coiffe porte-fusible sectionnable unipolaire (Parqué)
- 16) Montage sur adaptateur jeux de barres Top
- 17) Dimensions
- 18) Dimensions

**E****SE****Manual de instrucciones**

**Bases Portafusibles**  
**NH tripolares verticales T.00**  
**para embarrados de 185mm**

	<b>Atención!</b>
	Riesgo de descargas eléctricas y quemaduras. Desconectar antes de cualquier manipulación.

**Installations anvisning**

**Säkringslastbrytare storlek 00, avsedda för samlings-  
 skensystem med c/c 185mm. 1- och 3 polig manövrering.**

	<b>Varning</b>
	Livsfarlig spänning kan orsaka elchock och brännskador. Koppla ifrån spänningen före arbete på denna utrustning.



**Usar solo cartuchos fusible o cuchillas de  
seccionamiento con los contactos plateados!**



**Använd endast säkringar och kopplingsknivar  
med silverpläterade kontaktytor!**

- 1) Desmontar la parte superior de seccionamiento.

Retirar la parte superior de seccionamiento  
sin los cartuchos fusibles.

- 2) Desconexión

On/Off: Mover la manecilla rapidamente.

- 3) 1-polo (versión unipolar).
- 4) 3-polos (version tripolar).
- 5) Insertar los cartuchos fusibles.
- 6) Retirada del cartucho fusible.
- 7) Retirada del cartucho fusible en versión 3 polos.
- 8) Posición de parking en el desconectador de 3 polos.
- 9) Bloqueo por candado.
- 10) Retracción maneta de 1 polo
- 11) Embarrado de connexion.

Busbar thickness 5-10mm 6Nm  
 Espesor barras 5-10mm 6Nm.

- 12) Conexión superior.
- 13) connexion inferior.
- 14) Interruptor indicador de posición.
- 15) Posición de parking manecilla 1 polo
- 16) Montaje del adaptador de embarrados.
- 17) Dimensiones
- 18) Dimensiones

Sujeto a modificaciones técnicas

- 1) Ta bort den övre delen på säkringslastbrytaren.
- 2) Frånslag.
- 3) 1-polig version.
- 4) 3-polig version.
- 5) Montage av säkring.
- 6) Demontage av säkring.
- 7) Position för demontering av säkring, 3-polig version.
- 8) Parkeringsposition, 3-polig version.
- 9) Låsning av apparat.
- 10) Infällbart handtag, 1-polig version.
- 11) Krok för upphängning på samlings-skena. Tjocklek  
5-10mm.
- 12) Anslutning uppifrån.
- 13) Anslutning nedifrån  
 KU00 = 10-15Nm  
 Al/Cu 10-70mm<sup>2</sup>\*  
 Al/Cu 10-95mm<sup>2</sup>\*  
 Med dragavlastning  
 P00 = 2,6Nm  
 Al/Cu 10-70mm<sup>2</sup>\*  
 S00 = 2,6Nm  
 Al/Cu 1,5-70mm<sup>2</sup>\*
- 14) Microbrytare för lägesindikering.
- 15) Parkeringsläge, 1-polig version.
- 16) Montering på adapter.
- 17) Mått.
- 18) Mått.

**\* Anslutning av aluminiumledare:**

Avlägsna oxidbeläggningen på ledarändarna  
omedelbart före anslutning och behandla med syra-och  
alkali-fritt fett.

**18) Dimenzije**  
*Dimensions*

