

POWER FACTOR CONTROLLER

TECHNICAL MANUAL OF INSTALLATION

PFC6DA

PFC8DB

PFC12DB



INDEX

1. BUTTONS AND INDICATION LEDs _____	> Pg. 2
2. DESCRIPTION _____	> Pg. 2
3. OPERATION _____	> Pg. 2
4. ELECTRICAL DIAGRAM FOR INSTALLATION _____	> Pg. 3
5. SET-UP MENU _____	> Pg. 4
6. SETTING PASSWORD _____	> Pg. 7
7. SETTING AUTORECOGNIZED CAPACITOR BANK _____	> Pg. 7
8. MEASUREMENTS FUNCTIONS _____	> Pg. 8
9. COSφ AND SENSITIVITY SET-UP _____	> Pg. 9
10. OPERATION MODE _____	> Pg. 9
11. ALARMS TABLE _____	> Pg. 10
12. TECHNICAL DATA _____	> Pg. 11
13. TERMINAL CONNECTIONS _____	> Pg. 15
14. DIMENSIONS _____	> Pg. 15

AVAILABLE OPTIONAL COMMUNICATION MODULE PC-USB / RS485 / TTL - ORDER CODE: SCUSB485
REGISTERS MODBUS-RTU TABLE ON REQUEST













!!! IMPORTANT !!! READ THE INSTALLATION MANUAL BEFORE USE.





THE SAFETY OF THE PRODUCT IS STRICTLY RELATED TO ITS USE THAT HAS TO BE DONE AS SPECIFIED BY THE MANUFACTURER.

1 - BUTTONS AND INDICATION LEDs:

1.1 Indication LEDs

-  - Inductive Load.
-  - Capacitive Load.
-  - External Temperature (internal temperature sensor).
-  - Manual Operation Mode of the output relays.
-  - Automatic Operation Mode of the output relays.
-  - Phase Main Input Voltage.
-  - Phase Load Current.
-  - Needed kvar to achieve the $\text{Cos}\varphi$ adjustment.
-  - $\text{Cos}\varphi$ setting for the installation.
-  - Total Harmonic Current Distortion in %.
-  - On delay timer to switch the capacitors bank.

1.2 Buttons :

-  - Button selection for the operation mode , Manual or Automatic.
-  - Measurements Menu (V, A, kvar, $\text{Cos}\varphi$, THD, Sensitivity)
-  - Selected Value Decrease.
-  - Selected Value Increase.

2 - DESCRIPTION:

Control and digital $\text{Cos}\varphi$ regulation device with accurate and reliable $\text{Cos}\varphi$ readings, except possible errors deriving from ageing of electronic components.

By the mean of particular devices and algorithms, the instrument, controls even electric lines with an high harmonic contents. By calculating reactive power, it allows to intervene to connect the capacitor banks, which permits their best utilization both in number of operations and in equal rating of the capacitor banks.

3 - OPERATION:



> Device model:

At the switching on, for one second, type of device it's displayed the in the following way.

BOX	Model Type	Display LED	Steps
96x96	PFC6DA	00.6	06
144x144	PFC8DB	00.8	06
144x144	PFC12DB	0.12	12

> Output steps switching on test:

The parameters **P.01** to **P.06** must be programmed first (5.1 - Basic Set-up Menu).

Pressing button  or  the respective outputs and the LED will be activated, letting you test the connections.

4 - ELECTRICAL DIAGRAM FOR INSTALLATION:

Mono-Phase Wiring Diagram:

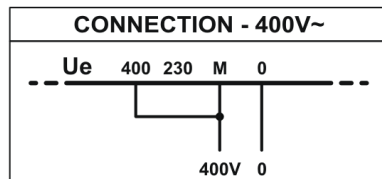
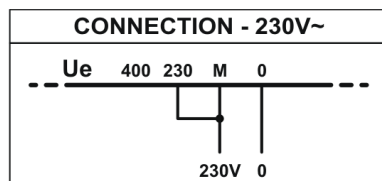
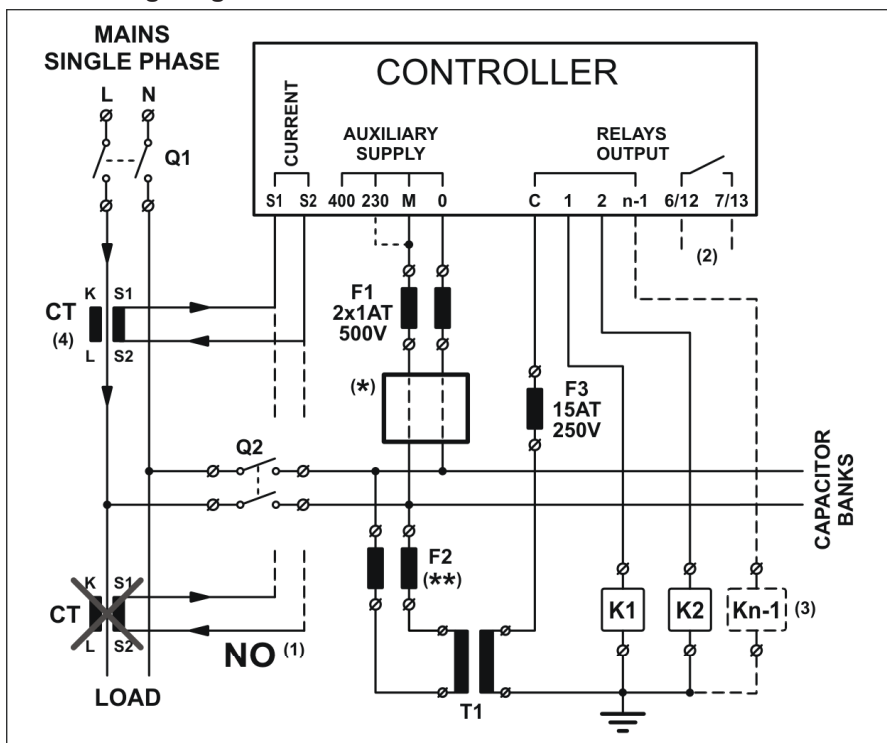

(*) OK if $P_{05} = 1$
 For supply voltage higher of supported range, insert one transformer and setting par. P_{05} with transformer ratio.

Ratio: $\frac{V_{OUT}}{V_{LINE}}$ Max. 440VAC

$\frac{V_{SET}}{V_{IN}}$

Three-Phase Wiring Diagram:

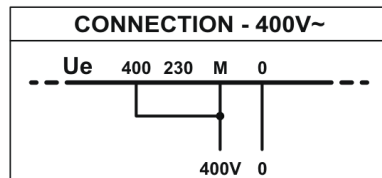
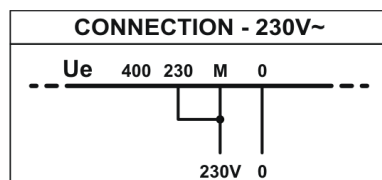
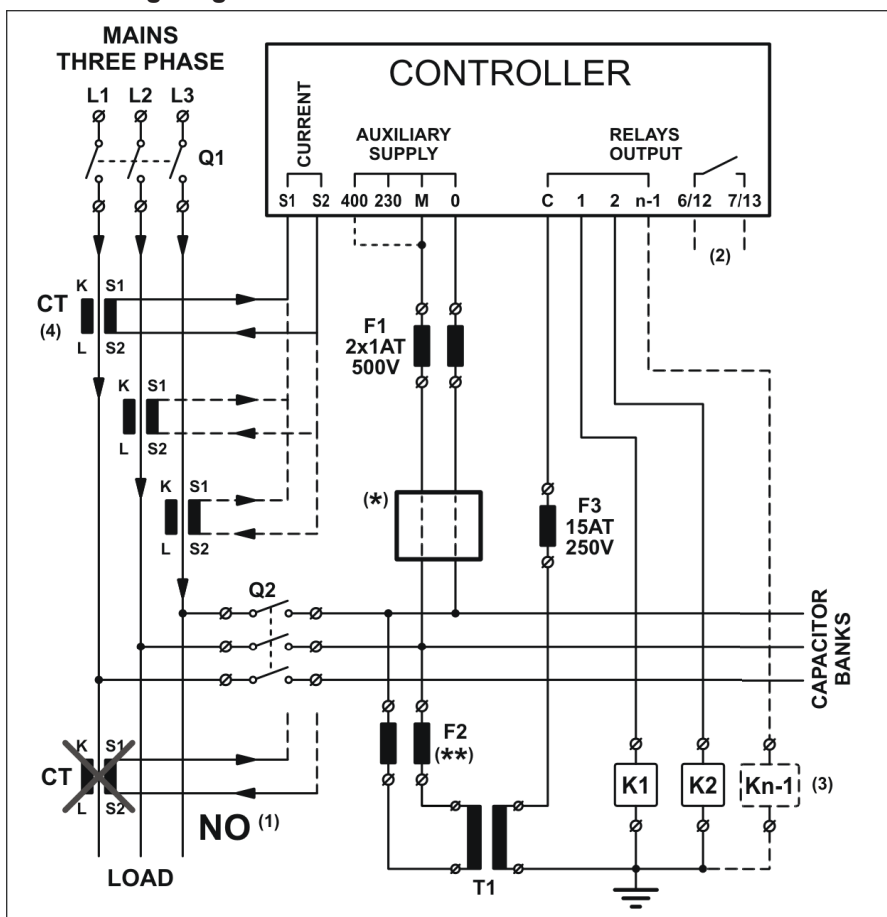

(*) OK if $P_{05} = 1$
 For supply voltage higher of supported range, insert one transformer and setting par. P_{05} with transformer ratio.

Ratio: $\frac{V_{OUT}}{V_{LINE}}$ Max. 440VAC

$\frac{V_{SET}}{V_{IN}}$

Q1 - The installer has to provide an external disconnection device; this breaker has to be easily reachable and identified as "disconnection device".

(**) - The value has to be calculated according to the T1 used.

NOTE:**The auxiliary transformer T1 is used for:**

- To isolate the controller aux circuit from the main circuit.
- When coil voltage of the contactors are different from the main voltage network.





- (1) On wrong connection, the measured $\text{Cos}\phi$ remain constant when we switch on the capacitors.
It is necessary to change the connection of CT before to connect it to a phase or a signal.
- (2) Last step contact (not present for DPFC04A model).
- (3) See Basic Set-up Menu **P.05** notes (5.1).
- (4) Setting polarity of CT current in Advance Set-up Menu (5.2):

Parameter	CT	Phase Displacement VI with $\text{Cos}\phi = 1$	CT - Phase Connection
P.02 = 1	Direct	90°	Current L1 – Power Supply L3-L2 <i>The Current phase is different to power supply phases</i>
P.02 = 2	Inverse	270°	
P.02 = 3	Direct	30°	Current L2 – Power Supply L3-L2 <i>The Current phase is coincident to a power supply phase</i>
P.02 = 4	Inverse	210°	
P.02 = 5	Direct	150°	Current L3 – Power Supply L3-L2 <i>The Current phase is coincident to a power supply phase</i>
P.02 = 6	Inverse	330°	









Attention: if the voltage between phase/neutral is more than 230V or, if between phase/phase is more than 400V, it is mandatory to use and external current transformer.

DEVICE STARTUP

At first start-up the display will show **CE** blinking, this means you need to set the value of the primary CT.

- Press the button  to show the parameters value **P.01**
- Press the button  to show the parameters value **000**
- Press the button  to increase or the button  to decrease the CT value set.
- Press the button  to save the desired value, the display will shows **SAU** and device will restart.



5 - SET-UP MENU:**5.1 ENTER THE BASIC SET-UP MENU:**

- The controller must be set on MANUAL operation and all capacitors must be OFF.
- Press the button  for 5 seconds.
- The display will show **SEt**
- The LED  and  will flash with 500ms frequency.
- Press the button  to show the parameters value **P.01**
- Press the button  to increase or the button  to decrease the value.
- Press the button  to advance to the next parameter programmed, press again to show the value.
- Press the button  to return to the programmed parameter.
- Proceed and program all parameters until the last **P.06**
- Press the button  to save all data, on display will shows **SAU** and exit the Basic set-up Menu.
All LEDs will light for a few seconds.
- If the display shows **Err**, it means that an error has happened and was not possible to save the data.
Therefore it will be necessary to program again all the parameters on the Basic set-up menu.











For a quick exit from the menu, press  for 3 seconds until display shows **SAU**

Basic Set-up Menu:

PARAMETER	DESCRIPTION	RANGE	DEFAULT
P.01	Primary current transformer. The first dot on the display flashes to indicate the scale in thousands.	0 / 5 ... 10000	0
P.02	Rated power (nameplate) in kvar of the smallest capacitor bank.	0.01...10000	0.10
P.03	Rated capacitor voltage (nameplate) in volts.	80 ... 30000	400
P.04	Reconnection time of the same step in seconds. (Capacitor discharge time)	1 ... 600	180
P.05 (LED 1)	Step 1 kvar	0 ... 10000	0
P.05 (LED 2)	Step 2 kvar	0 ... 10000	0
P.05 (LED X)	Follow the same programming as above, except for the last TWO steps.	0 ... 10000	0
P.05 (LED N-1)	Programming of the last before last step. kvar or external fan (a)	0 ... 10000 FRn	0
P.05 (LED N) (b)	Programming of the last step. kvar or alarm output (c)	0 ... 10000 noA - ncA	0
P.06	Voltage transformer ratio (ex. $V_{LINE} / V_{SET} = 500 / 400 = 1.25$)	0.40 ... 100	1.00

<p>(a) External fan: press the button  until the display shows FRn</p> <p>The temperature operation control should be set on the Advance Menu A.11 and A.12</p> <p>(b) Last step: it can be 04/06/08/12 depending on the version (not present for DPFC04A model).</p> <p>(c) Alarm output: when the display shows 000, pressing the  key, the letters ncA appears (normal close alarm) which means the alarm relay normally energized that is closed contact in the absence of alarm.</p> <p>Pressing again, the function is inverted and display show noA</p>

5.2 ENTER THE ADVANCED MENU:

- The controller must be set on MANUAL operation and all capacitors have to be disconnected.
- Press the button  for 5 seconds.
- The display will show **SEt**
- The LED  and  will flash with intermittence of 500ms.
- Press both buttons together  and  for 2 seconds until the display shows **SEt.A**
- Press the button  to show **A.01**, press again for the parameters value.
- Press the button  to increase or the button  to decrease the value.
- Press the button  to advance to the next programmed parameter, press again to show the parameter value.
- Press the button  to return on the programmed parameter.
- Proceed and program all parameters until the last **A.18**
- After last parameter value press the button  to save the data, display will shows **SAU** and exit the Advance Menu. All LEDs will flash for a few seconds.
- If the display shows **Err**, it means that an error has happened and was not possible to save the data. Therefore it will be necessary to program again all the parameters on the Advance Menu.

For a quick exit from the menu, press  for 3 seconds until display shows **SAU**

Advance Set-up Menu:

PARAMETER	DESCRIPTION				RANGE	DEFAULT		
A.01	Mains Connection	0 = Three-Phase	1 = Single-Phase		0 ... 1	0		
A.02*	Sense of CT current	1 = CT on L1 Direct	2 = CT on L1 Inverse		1 ... 6	1		
		3 = CT on L2 Direct	4 = CT on L2 Inverse					
		5 = CT on L3 Direct	6 = CT on L3 Inverse					
A.03	Frequency	1 = 50 HZ	2 = 60 HZ		1 ... 2	1		
A.04	Serial interface TTL	0 = Disable	1 ... 99 = Enable		0 ... 99	1**		
A.05	Temperature Alarm	0 = Disable	35 ... 158 = Enable		0 / 35 ... 158	45 (°C)		
A.06	Temperature scale	0 = °C	1 = °F		0 ... 1	0		
A.07	Alarm THD (%) I				5 ... 200	120		
A.08	THD(%) Delay on (seconds)				1 ... 600	5		
A.09	Alarm relay (see Table pag.10)	0 = None	2 = <i>A.HU</i>	4 = <i>A.HI</i>	6 = <i>A.HC</i>	8 = <i>A.LH</i>	0 ... 9	1
		1 = All	3 = <i>A.LU</i>	5 = <i>A.LI</i>	7 = <i>A.LC</i>	9 = <i>A.LS</i>		
A.10	Time to switch off all the capacitors because of low current (seconds).				1 ... 240	120		
A.11	Min Temp. to switch off the fan relay output. (if selected °F set the right value)				1 ... 240	30		
A.12	Max Temp. to switch on the fan relay output. (if selected °F set the right value)				1 ... 240	50		
A.13	Mains Three Phase Voltage.				220 ... 440 with step of 5	400		
A.14	Fixed step selection (0=none)				0 ... 12	0		
A.15	0 = kvar with subtraction fixed step		1 = Real kvar		0 ... 1	1		
A.16	Serial Protocol Type	0	Proprietary	9600 Bds	EVEN	1 Bit Stop	0 ... 15	0
		1	Modbus	19200 Bds	EVEN	1 Bit Stop		
		2	Modbus	9600 Bds	EVEN	1 Bit Stop		
		3	Modbus	4800 Bds	EVEN	1 Bit Stop		
		4	Modbus	2400 Bds	EVEN	1 Bit Stop		
		5	Modbus	1200 Bds	EVEN	1 Bit Stop		
		6	Modbus	19200 Bds	ODD	1 Bit Stop		
		7	Modbus	9600 Bds	ODD	1 Bit Stop		
		8	Modbus	4800 Bds	ODD	1 Bit Stop		
		9	Modbus	2400 Bds	ODD	1 Bit Stop		
		10	Modbus	1200 Bds	ODD	1 Bit Stop		
		11	Modbus	19200 Bds	NONE	1 Bit Stop		
		12	Modbus	9600 Bds	NONE	1 Bit Stop		
		13	Modbus	4800 Bds	NONE	1 Bit Stop		
		14	Modbus	2400 Bds	NONE	1 Bit Stop		
		15	Modbus	1200 Bds	NONE	1 Bit Stop		
		16	Proprietary	9600 Bds	NONE	1 Bit Stop		
17	Proprietary	4800 Bds	NONE	1 Bit Stop				
A.17	Anti-Hunting	0 = Disable	0.90 ... -0.95 = Enable		0 / 0.90 ... -0.95	0		
A.18	Threshold for Cosφ alarm	0 = Disable	0.50 ... 0.95 = Enable		0 / 0.50 ... 0.95	0		
A.19	Delay between steps		Switch-ON / Switch-OFF (in sec. with step of 0.1)		1.00 ... 5.00	1.00		

* When the **A.02** value is displayed, by pressing together  and , the updated Cosφ it's immediately shown.

** The values 1 to 99 indicate the device number when the units are connect on a serial interface, the values 100 to 199 aren't used.

5.3 TO SET DEFAULT PARAMETERS:

- In **A.01** parameter, press all buttons together     for 5 seconds, on display will shows **SAU**
Now the device will restart.

ATTENTION: All settings made on the device will be lost and all steps will be restored to default setting.

5.4 ENTER THE ALLARM MENU:

- a) The controller must be set on MANUAL operation and all capacitors must be OFF.
- b) Press the button  for 5 seconds.
- c) The display will show *SEt*
- d) The LED  and  will flash with intermittence of 500ms.
- e) Press both buttons together  and  for 2 seconds until the display shows *SEt.A*
- f) The LED  and  will flash with intermittence of 500ms.
- g) Press the button  for 5 seconds.
- h) The display will show *A.HU*
- i) Press the button  for to enter in alarm's parameter, shows the *E.nb*.
- j) Press the button  for to enter for set the value.
- k) Press the button  to increase or the button  to decrease the value.
- l) Press the button  for to enter in alarm's parameter, shows the *d.t.*
- m) Press the button  for to enter for set the value.
- n) Press the button  to increase or the button  to decrease the value.
- o) Press the button  for to enter in alarm's parameter, shows the *d.u.*
- p) Press the button  for to enter for set the value.
- q) Press the button  to increase or the button  to decrease the value.
- r) Press the button  for to enter in alarm's parameter, it shows the *d IS.*
- s) Press the button  for to enter for set the value.
- t) Press the button  to increase or the button  to decrease the value.
- u) Press the button  display will show *A.HU*.
- v) Press the button  for to get another alarm.
- w) Repeat the procedure from point " i) " to set the parameters
- x) When the display will show *A.CS*, to exit the Alarm Menu, press  to save the data, display will show *SAU* and exit the Alarm Menu.
- y) All LEDs will flash for a few seconds.
- z) If the display shows *Err*, it means that an error has happened and wasn't possible to save the data. Therefore it will be necessary to program again all the parameters on the Alarm Menu.

For a quick exit from the menu, press  for 3 seconds until display shows *SAU*

Alarm Set-up Menu:

PARAMETER	Description	Range Enable <i>E.nb</i> (default)	Range value <i>d.t.</i> (default)	Range time <i>d.U.</i> (default)	Range Dis. Steps <i>d.IS.</i> (default)
<i>A.HU</i>	Too High Voltage	0 ... 1 (1)	1 ... 240 (15)	Min/Sec (Min)	0 ... 1 (1)
<i>A.LU</i>	Too Low Voltage	0 ... 1 (1)	1 ... 240 (5)	Min/Sec (Sec)	0 ... 1 (0)
<i>A.HI</i>	Too High Current	0 ... 1 (1)	1 ... 240 (2)	Min/Sec (Min)	0 ... 1 (0)
<i>A.LI</i>	Too Low Current	0 ... 1 (1)	1 ... 240 (5)	Min/Sec (Sec)	0 ... 1 (1)
<i>A.HC</i>	Over Compensation	0 ... 1 (1)	1 ... 240 (2)	Min/Sec (Min)	0 ... 1 (0)
<i>A.LC</i>	Under Compensation	0 ... 1 (1)	1 ... 240 (15)	Min/Sec (Min)	0 ... 1 (0)
<i>A.ot</i>	Over Temperature	0 ... 1 (1)	1 ... 600 (10)	Min/Sec (Sec)	0 ... 1 (0)
<i>A.tH</i>	THD % I	0 ... 1 (1)	1 ... 240 (3)	Min/Sec (Sec)	0 ... 1 (1)
<i>A.CS</i>	Low Cosφ	0 ... 1 (1)	1 ... 240 (60)	Min/Sec (Sec)	0 ... 1 (0)

PARAMETER	DESCRIPTION
<i>E.nb</i>	Enable alarm: if a 1 = Enable, if a 0 = Disable.
<i>d.t.</i>	Delay value before the activation of the alarm relay or before the alarm being shown on display.
<i>d.U.</i>	Select Min = Minutes or Sec = Seconds time unit that will take the value <i>d.t.</i>
<i>d.IS.</i>	On alarm, disconnect steps: if a 1 = Enable, if a 0 = Disable.

6 - SETTING PASSWORD:

Default password is **000** and not active as default.



a) The controller must be set on MANUAL operation and all capacitors must be OFF.

b) Press the button  for 5 seconds.

c) The display will show **SEt**

d) The LED  and  will flash with intermittent of 500ms.

e) Press the button  for 10seconds until display will show **5.P5**

f) To change password value press  or .

g) To save new password press  for 5 seconds until display will show **SAU**

h) To exit without save password press  when password value is show.

i) Now you can view but not modify the parameters.

l) When you try to change the parameters the display show **PAS**, then pressing the keys  or  set the password and confirm by pressing 





m) If the password is correct you have access to edit parameters. After 5 minutes everything will relock again.

n) If the password is incorrect the display shows **Err.**

o) When the instrument requires the password, you have 30secs to enter it, otherwise the system will return to the normal operation.

p) To disable the password set the value **000**, or in extreme cases carry out reset (5.3 - Set Default Parameters).





7 - SETTING AUTORECOGNIZED CAPACITOR BANK:

- a) The controller must be set on MANUAL operation and all capacitors must be OFF.
- b) Press the button  for 5 seconds.
- c) The display will show **SEt**
- d) The LED  and  will flash with intermittent of 500ms.
- e) Press the button  until the display show the parameters value **P.05**
- f) Press the button  for 10 seconds until display will show **Aut** and start the automatic recognition of steps kvar.

This operation can take some minutes, at the end the display show **P.05**

Warning, the load must be stable during recognition, or wrong values of steps will be set.









However, when recognition is over, you can check and set the steps manually if values are wrong.

- g) Press the button  for scroll through the steps and see the banks acquired.
- h) If the value is wrong press the button  to increase or  to decrease.
- i) Now press the button  to save all data, the display will show **SAU** and exit the Basic set-up Menu.

All LEDs will flash for a few seconds.

ATTENTION: Capacity below 100VAR are recognized as 0.

8 - MEASUREMENTS FUNCTIONS:

- a) In operation mode the display shows the $\text{Cos}\varphi$ of the installation and, if the load are inductive  or capacitive .
- On $\text{Cos}\varphi$ value indication, if the decimal point on first digit (from left) is flashing, this is because the system working as Generator and the sense of current is inverted (verify correct CT connection or modify parameter **A.02**).
- b) Press the button  to scroll on available measurements indicated by the related LED.
- c) If a value is above 1000, the decimal point will flash. If the value is below 1000 the decimal point light is fixed.
- d) Select  measure, the display will show the kvar needed to achieve the $\text{Cos}\varphi$ adjustment.
- Pressing the button  the display will show the correct value measured by the controller of the minimum capacitor step set on **P.02**
- Pressing the button , the display will show the numbers of minimum step capacitor (programmed on **P.02**) that will be needed to reach the desired $\text{Cos}\varphi$.
- e) If the Δkvar LED  is ON, the installation is inductive and needs to switch on the capacitor to reach the value of $\text{Cos}\varphi$ programmed.
- f) If the Δkvar LED  is ON, the $\text{Cos}\varphi$ of the installation is capacitive and needs to switch off the capacitor to reduce the $\text{Cos}\varphi$ to the value programmed.
- g) Press the button  to verify the equivalent number of steps that must be switched ON (load inductive) or OFF (load capacitive) to reach the $\text{Cos}\varphi$ programmed.
- h) If no button is pressed for 30 seconds, the display will return to show the $\text{Cos}\varphi$ of the installation.

i) Select  measure, the display will show the Mains Input Voltage of phase.

By pressing and holding , the display will show the total kVA of the system.

By pressing and holding , the display will show the total kW of the system.

In Manual Mode  press together  and , the  LED blink and the display will show the maximum Voltage value.

l) Select  measure, the display will show the Load Current of phase.

By pressing and holding , the display will show the total kvar of system.

In Manual Mode  press together  and , the  LED blinks and the display will show the maximum Current value.

m) Select  measure, the display will show the ambient temperature.

By pressing and holding , the display will show the total working Hours.



In Manual Mode  press together  and , the  LED blink and the display will show the maximum Temperature value.



n) Select  measure, the display will show the Total Harmonic Current Distortion in %.

In Manual Mode  press together  and , the  LED blink and the display will show the maximum THD value.

9 - $\text{COS}\phi$ SET-UP AND SENSITIVITY SET-UP:

9.1 $\text{Cos}\phi$ set-up:

Press the button  until the LED  turns ON.

Press the button  to increase the value or the button  to decrease the value.

The LED  ON indicates that the instantaneous $\text{Cos}\phi$ of the installation is inductive.

The LED  ON indicates that the instantaneous $\text{Cos}\phi$ of the installation is capacitive.

9.2 Sensitivity:

This value refers to the time that unit takes to measure the average $\text{Cos}\phi$ of the installation and do the necessary actions on the capacitors relays.

The unit of sensitivity is: sec/kvar (The kvar of the lowest capacitor programmed on *P.02*).

> Press the button  until the  LED lights ON.

> Press the button  or  to modify the value of sensitivity programmed.

> The time needed to turn ON the step relay depends on the time of Reconnection of the step. (*P.04*).

9.3 Example:

If we need to switch ON 20 kvar. Parameters programmed on the device:

P.02 (lowest step): 10 kvar

Sensitivity programmed: 60 sec/kvar (lowest step on **P.02**)

We will have: Reactive power needed of 20 kvar is equal to 2 x 10 kvar (lowest step on **P.02**)

Therefore, The device will switch On the step in: 60sec / 2 = 30sec

10 - OPERATION MODE:

!!! ATTENTION !!!

The operating mode can't be changed if **LED Δ kvar**, **Set Cos ϕ** or **SENSITIVITY** is switched on.

1. Press the button  for 1 second to select the mode (Manual or Automatic)

2. The LED  or  will indicate the selected mode.

3. The operating mode remains stored even in absence of supply voltage.

Note: If several steps are inserted, switching from automatic to manual mode, the connected steps will be disconnected.

10.1 MANUAL OPERATION MODE:

During Manual operation mode, the status of step relays is stored even in the absence of supply voltage to the unit.

When the power is back, the unit will return to the stored status.

1. Only when you show  value, pressing the button  or  to select the relay to be activated and the correspondent LED will blink.

2. Press the button  within 5 seconds of step selection, to modify the status of the output relay (turn On or turn OFF).

3. Repeat the above operation for the next steps to be examined.

4. If the last step is programmed as Alarm relay, then the relay can not be driven manually.

Note: During Manual operation the device controls the reconnection time of the capacitors (same as discharge time of the capacitor on **P.04**), therefore to switch ON the same steps it will be necessary to wait for the reconnection time programmed.

10.2 AUTOMATIC OPERATION MODE:

During automatic operation the PFC will consider the Cos ϕ of the installation and the Set Cos ϕ programmed.

1. If the  LED is flashing, the controller is ready to switch On or Off the steps.

2. If the reaction time of the instrument seems to be too long, this is because the Cos ϕ controller is waiting for the reconnection settled time (**P.04**).

3. The instrument uses the best choice combination of the following options listed below (in decreasing priority level):

- Reactive power needed.
- Reconnection time for the selected step.
- Number of switching necessary to reach the desired Cos ϕ .
- Number of the effective insertions and connections.
- Total time need of the effective insertions/connections.

4. The software also includes the Anti-Hunting protection for the capacitors to prevent inconvenient switch on/off when trying to correct the Cos ϕ of installation if the available capacitor is too big.
The new Cos ϕ measure must be less than 1.00 with the capacitor is on.

11 - ALARMS TABLE:

1. In manual mode the alarms are just a display indication.
2. Pressing the  button the visual alarm can temporarily be cancelled, and the readings can be shown to verify the causes of the alarms.
If, for 30 seconds no button is pressed, the visual alarm returns until its removal.

Code	Description	Delay (default)	Intervention Parameter	Display LED
<i>A.HU</i>	Too high voltage	15min	Voltage over +10% set value.	Display <i>A.HU</i> VOLTAGE LED blink
<i>A.LU</i>	Too low voltage	5sec	Voltage under -15% set value	Display <i>A.LU</i> VOLTAGE LED blink
<i>A.HI</i>	Too high current	2min	Current exceeds 110% of the rated value.	Display <i>A.HI</i> CURRENT LED blink
<i>A.LI</i>	Too low current	5sec	Current is lower than 2.5% rated value. If the alarm condition persists for a time exceeding 2 minutes, then the outputs are disabled.	Display <i>A.LI</i> CURRENT LED blink
<i>A.HC</i>	Overcompensation	2min	Capacitors are all disconnected and the $\text{Cos}\varphi$ is higher than the preset value.	Display <i>A.HC</i> alternated with $\text{Cos}\varphi$ value
<i>A.LC</i>	Under compensation	15min	Capacitors are all connected and the $\text{Cos}\varphi$ is lower than the preset value.	Display <i>A.LC</i> alternated with $\text{Cos}\varphi$ value
<i>A.Ot</i>	Over temperature	10sec	The temperature refers to <i>A.OS</i> set value.	Display <i>A.Ot</i> alternated with $\text{Cos}\varphi$ value
<i>A.tH</i>	THD % I	5sec	When the THD is higher than the value set on par. <i>A.O7</i>	<i>A.tH</i> alternated with THD%
<i>A.PS</i>	Set-up parameters error	-	The set-up parameters read by the EEPROM aren't correct. To restore is necessary the re-set made by the user.	Display <i>A.PS</i>
<i>A.PC</i>	Adjustment/setting parameters error	-	The setting parameters read by the EEPROM aren't correct. The device operates with the default parameters. There could be error in the calculated measures. The user can't do the setting. It is necessary to return the unit to the manufacturer.	Display <i>A.PC</i>
<i>A.PU</i>	Parameters error	-	The setting parameters read by the EEPROM aren't correct (set $\text{Cos}\varphi$, sensitivity, operation mode). To reset is necessary to contact the manufacturer.	Display <i>A.PU</i>
<i>A.EE</i>	Cancellation EPROM error	-	Only in the testing phase you can see if the EEPROM doesn't operates correctly. Is necessary to contact the manufacturer.	Display <i>A.EE</i>
<i>A.Fr</i>	Frequency error	0	If frequency is out of +5% of selected value in <i>A.O3</i> Check the parameter <i>A.O3</i> The frequency is checked only at power on.	Display <i>A.Fr</i>
<i>A.CS</i>	Low $\text{Cos}\varphi$	60sec	When the $\text{Cos}\varphi$ is lower than the value set on par. <i>A.1B</i>	Display <i>A.CS</i> alternated with $\text{Cos}\varphi$ value

12 - TECHNICAL DATA:

Supply Circuit	96x96 - Model	144x144 - Model
Supply Voltage	230/400V~	230/400V~
Operating Limits	-15%...+10% Ue	-15%...+10% Ue
Rated Frequency	50 or 60Hz	50 or 60Hz
Power Consumption L/L - 400V~	5.8 VA	6.1 VA
Immunity time for Microbreakings	<6ms	<6ms
Measurement/Overvoltage Category	Class II	Class II

Current Input	96x96 - Model	144x144 - Model
Rated Current	5A	5A
Operating Limits	0.125...5.5A	0.125...5.5A
Rated Voltage	230V~	230V~
Overload Capacity	1.1Ie	1.1Ie
Overload Peak	10 Ie for 1sec	10 Ie for 1sec
Measurement/Overvoltage Category	Class II	Class II

Reading and Control Range	96x96 - Model	144x144 - Model
Voltage Reading Limits	195...460 V~	195...460 V~
Current Reading Limits	0.125...5.5A	0.125...5.5A
Type of Current and Voltage Readings	TRMS	TRMS
Cosφ Adjustment	0.85 inductive...0.95 capacitive	0.85 inductive...0.95 capacitive
Tripping Sensitivity	5...600 s/step	5...600 s/step
Re-connection Time of the Same Step	1...600 seconds	1...600 seconds
FFT - Harmonic Spectrum	THD% - 64st	THD% - 64st

Relay Outputs	96x96 - Models	144x144 - Model
Number of Outputs	04 - 06	04 - 06 - 08 - 12
Contact Arrangement	1NO	1NO
Contacts Capacity	8A - 250V~ (AC1)	8A - 250V~ (AC1)
Maximum Capacity the Common Contacts	10A	10A
Insulating Category/Rated Voltage VDE0110	C/250 - B/400	C/250 - B/400
Maximum Switching Voltage	250V~	250V~
Electrical Contact Life	20 x 10 ⁶ ops	20 x 10 ⁶ ops
Mechanical Contact Life	100 x 10 ³ ops	100 x 10 ³ ops

Enclosure and Connections	96x96 - Model	144x144 - Model
Cable Type for connection	Only 90°C - 1.5/2.5mm ² - 16/14 AWG	Only 90°C - 1.5/2.5mm ² - 16/14 AWG
Enclosure Version	Flush mount 96x96	Flush mount 144x144
Temperature Work	-10 / +50 °C	-10 / +50 °C
Operating Altitude	Up to 2000m	Up to 2000m
Pollution Degree	2	2
Electrical Insulation - Mains/Contact	4 kV	4 kV
Protection Degree	IP41 Front - IP20 Terminals	IP41 Front - IP20 Terminals
Relative Humidity w/o Condensation	95 RH%	95 RH%
Dimensions	96 x 96 x 74mm	149 x 149 x 60mm
Weight	350g - 370g	520g - 540g - 650g - 700g

Serial Interface	96x96 - Model	144x144 - Model
TTL	Standard	Standard
Communication Protocol	Proprietary / MODBUS RTU	Proprietary / MODBUS RTU
Connector Type	RJ11	RJ11

Serial Adapter TTL / USB / 485	ALL MODELS
Connector RJ11 / USB / 485	Optional order code SCUSB485

EC Directives: - 2006/95/EC - Low Voltage
- 2004/108/EC - EMC

Norms Compliance: CE marking

- IEC EN 55022 - IEC EN 61000-4-2 - IEC EN 61000-4-3 - IEC EN 61000-4-4 - IEC EN 61000-4-5
- IEC EN 61000-4-6 - IEC EN 61000-4-11 - IEC EN 61000-6-2 - IEC EN 61000-6-4 - IEC EN 61010-1
- IEC EN 61010-2-030

13 - TERMINAL CONNECTIONS:

96x96 - MODEL

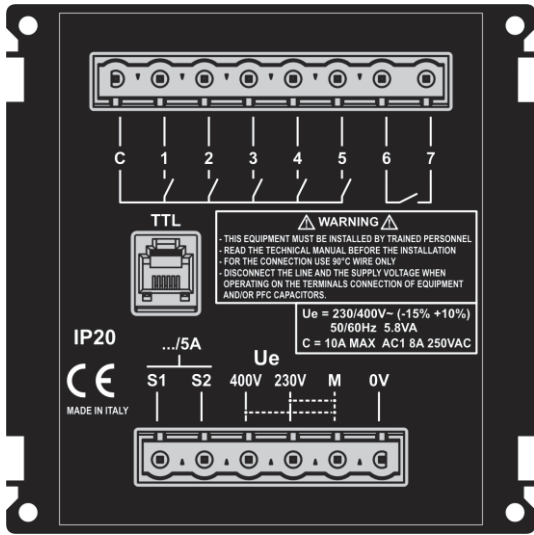

* The 96x96 picture shows the TTL version (optional)

144x144 - MODEL

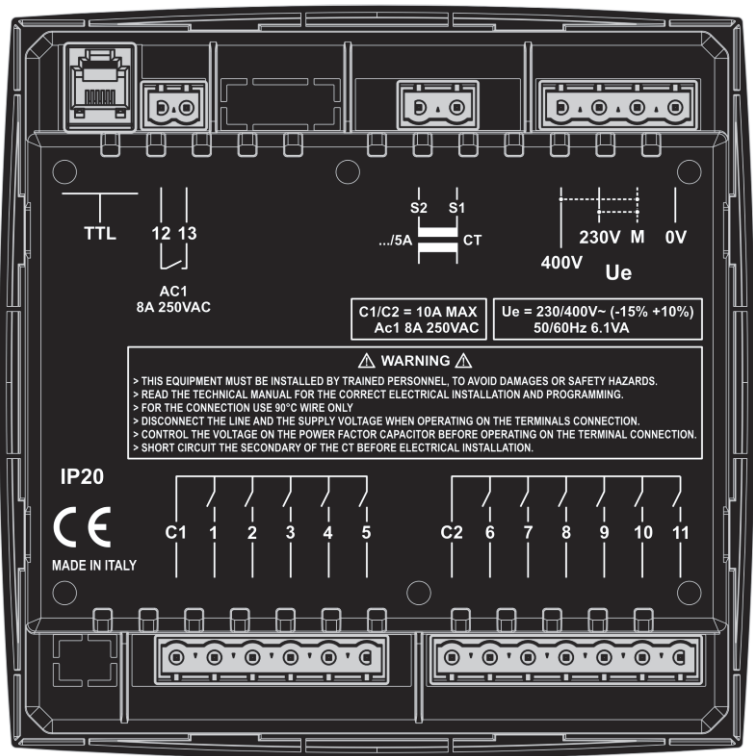

14 - DIMENSIONS:

96x96 - MODEL

FRONT VIEW

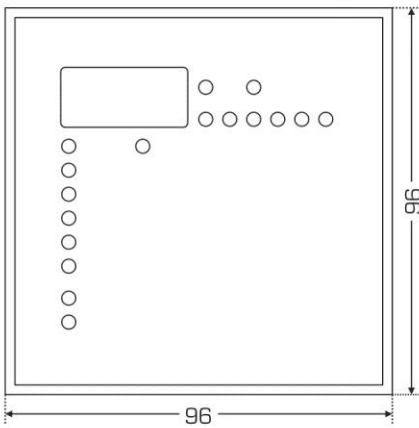

SIDE VIEW

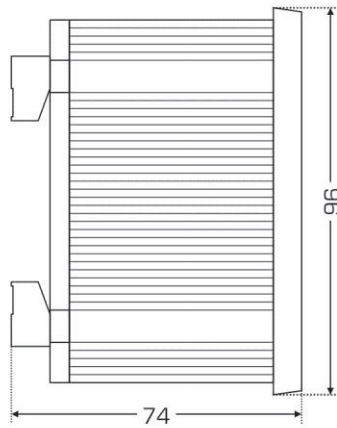

PANEL HOLE

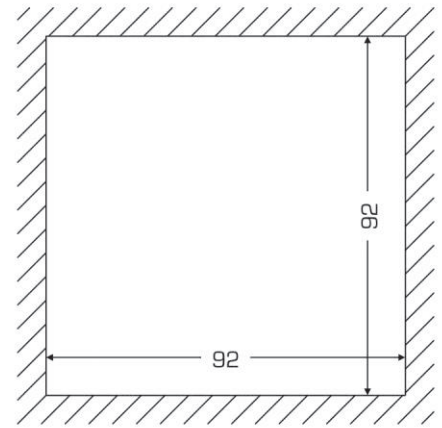

144x144 - MODEL

FRONT VIEW

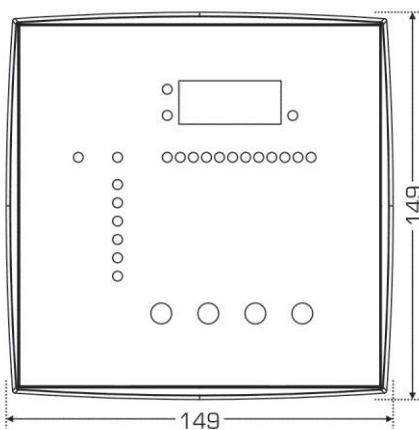

SIDE VIEW

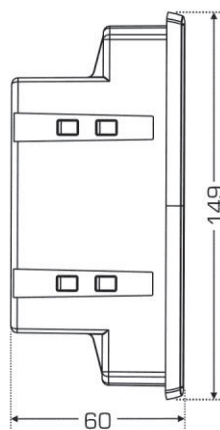

PANEL HOLE

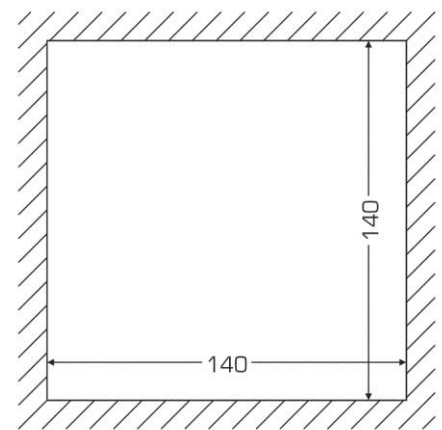

CLEANING OF THE UNIT:

If necessary clean the device with a soft cloth dampened with water.

This operation must be done with the instrument switched off and disconnected from any power source.

